

SPRN

REVERSE BALANCED SEAL

- METAL FREE CONTACT PARTS
- REVERSE BALANCED DESIGN
- CAN TOLERATE PRESSURE REVERSAL
- SUBSTITUTES PTFE BELLOW SEAL AT HIGHER PRESSURES AND TEMPERATURES
- CAN BE USED ON PRODUCT SIDE FOR BACK TO BACK DOUBLE SEALS

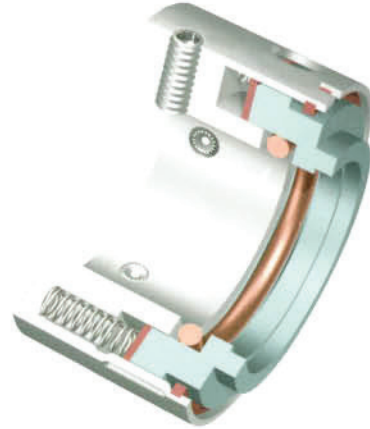

SPRN-C

REVERSE BALANCED COMPACT SEAL

- METAL FREE CONTACT PARTS
- COMPACT DESIGN
- INTERCHANGEABLE WITH CONVENTIONAL PUSHER SEALS
- IDEAL CHOICE FOR PRODUCT SIDE SEAL FOR B/B ARRANGEMENTS
- AVAILABLE WITH HARD FACE COMBINATION
- CAN BE INSTALLED ON ANSI, DIN & ISO STANDARD BORE PUMPS

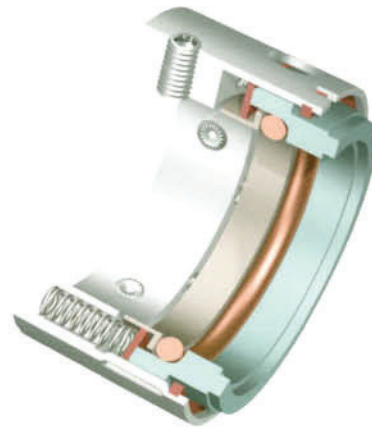

LIMITING PARAMETERS

PRESSURE
SPRN : 16 BAR SPRN-C : 6 BAR

TEMPERATURE
UP TO 280°C DEPENDING ON ELASTOMER

SPEED
26 m/sec

MATERIALS

METAL PARTS
SS316 ALLOY-20 HAST-C

FACE COMBINATIONS	
ROTARY	STATIONARY
CARBON	CERAMIC, SiC, TC
SiC	SiC

ELASTOMERS
VITON, NBR, SILICON NEOPRENE, EPDM, AFLAS FFKM, STV

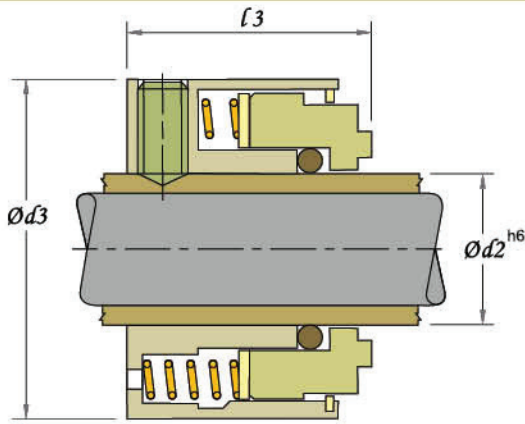

SPRN

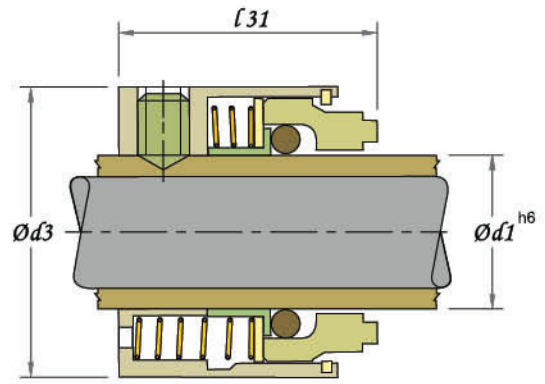

SPRN-C

INCH SIZES

SEAL CODE	d2	d3	l3
0254	19.05	40.4	28.6
0285	22.22	43.6	28.6
0317	25.40	48.3	28.6
0349	28.57	49.6	29.4
0381	31.75	53.2	29.4
0412	34.92	56.3	29.4
0444	38.10	59.5	29.4
0476	41.27	63.5	29.4
0508	44.45	66.7	29.4
0539	47.62	71.4	29.4
0571	50.80	72.2	29.4
0603	53.97	76.2	34.1
0635	57.15	79.4	34.1
0666	60.32	82.5	36.5
0698	63.50	85.7	36.5

DIMENSIONS FOR HIGHER SIZES AVAILABLE ON REQUEST

SEAL CODE	d1	d3	l31
0285	25.40	43.6	28.6
0317	28.57	48.3	28.6
0349	31.75	49.6	29.4
0381	34.92	53.2	29.4
0412	38.10	56.3	29.4
0444	41.27	59.5	29.4
0476	44.45	63.5	29.4
0508	47.62	66.7	29.4
0539	50.80	71.4	29.4
0571	53.97	72.2	34.1
0603	57.15	76.2	34.1
0635	60.32	79.4	34.1
0666	63.50	82.5	36.5
0698	66.67	85.7	36.5
0730	69.85	93.7	38.1

ALL DIMENSIONS IN MM



DESIGN VARIATIONS

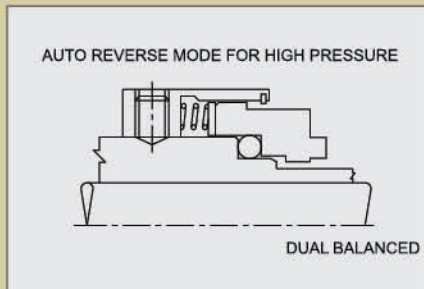
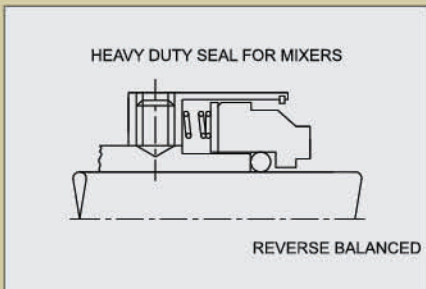

ARRANGEMENT

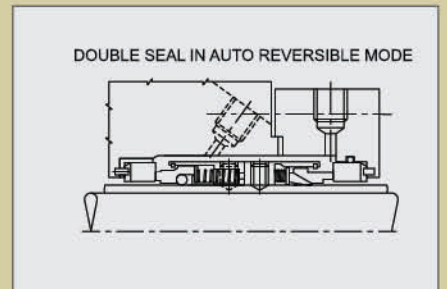

Due to continuous improvement specifications & dimensions may change without prior notice